

Data Sheet



Article number: 03705018

Description: Fluro rod end BRM 18 L
threaded left with ball bearing

Measures

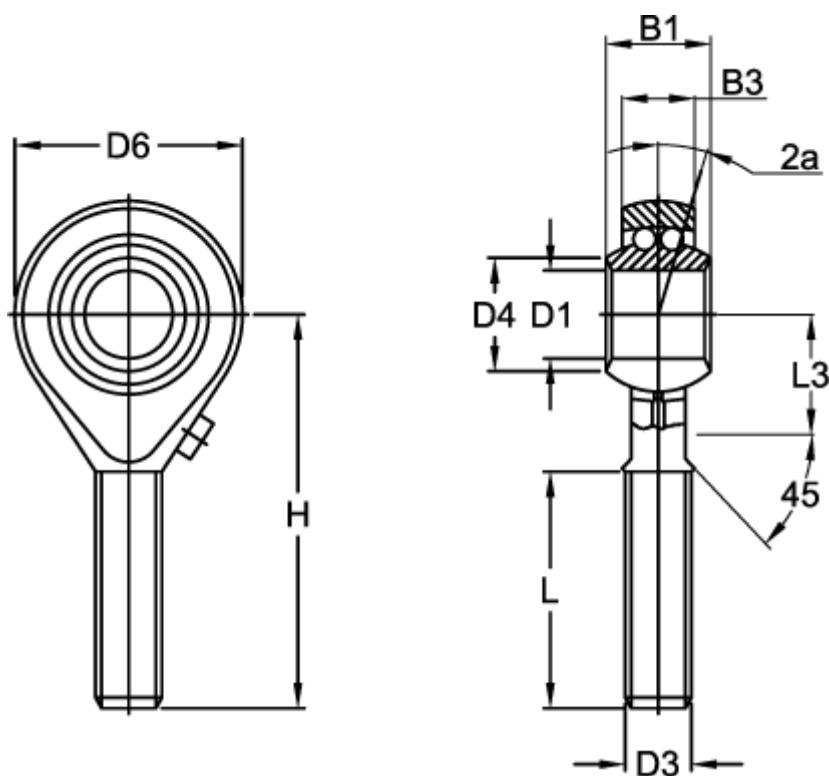

Angel 2a	= 8.5	H	= 72
B1	= 23	L	= 44
B3	= 16.50	L3	= 25
D1	= 18	Max rpm	= 900
D3	= M18x1,5	Static load (N)	= 2900
D4	= 21.5	Weight (kg)	= 0.270
D6	= 46		
Dynamic load C (N)	= 7100.0		